



ROC-3HE

Reverse Osmosis System Controller Documentation

Document Revised Sept. 2018

©2006-2018 iControls Technologies Inc.

iControls Technologies Inc.

1821 Empire Industrial Court, Suite A

Santa Rosa, CA 95403

ph (707) 324-0724

www.icontrols.net

Welcome.

Thank you for purchasing an iControls controller.

You made a good choice in choosing iControls. You can expect years of trouble-free service. With a design based on feedback from leaders in the RO field plus our own experience in RO system design and manufacture, iControls RO controllers are truly best in class.

As good as our controllers are, there's always room for improvement. If you have an experience, idea or input either positive or negative we'd love to hear from you.

Again, thanks for your purchase. Welcome to the community of iControls users.



David Spears

President,
iControls Technologies Inc.

david@icontrols.net

Table of Contents

Description	Page
Specifications, Table 1 _____	4
Schematic, Figure 1 _____	5
Field Wiring Diagram, Figure 1.1 _____	6
Controller Overview, Figure 2_____	7
Controller Detail: CPU-4 _____	8
Controller Detail: TB-6_____	9
Conductivity Probe Installation, Figure 5 _____	10
Controller Programming: Accessing Hidden Menus, Figure 6 _____	11
Controller Programming: Program Selections, Table 2 _____	12
Controller Programming: Parameters Explained, Appendix A _____	13-14
Controller Fault Displays _____	15
Controller Programming: Programming Interface Overview _____	16
Warranty _____	17

Table 1. Specifications

Inputs

Tank level switches	(2) Normally-Closed. <i>Can be used with a single level switch.</i>
Inlet pressure switch	Normally-Open.
Pretreat lockout switch	Normally-Open.
High Pressure switch	Normally-Open.
Controller Power	100-240 VAC, 60/50Hz (Switching power supply automatically adjusts)
Permeate Conductivity	0-3000 PPM, 0-6000 μ s (standard sensor, CP-1, K=.75)
Feed Conductivity (opt)	0-3000 PPM, 0-6000 μ s (standard sensor, CP-1, K=.75)

Output Relay Ratings (relays are fused with a 6A fuse)

Feed Solenoid	0.5A. <i>Voltage is the same as motor/supply voltage.</i>
Flush Solenoid	0.5A. <i>Voltage is the same as motor/supply voltage.</i>
Motor Contactor Coil	0.5A. <i>Voltage is the same as motor/supply voltage.</i>
Motor Contactor	
ROC-3HE-20	20A Definite Purpose Contactor: 3.0 HP @ 208-240V.
ROC-3HE-40	40A Definite Purpose Contactor: 5.0 HP @ 208-240V.

Circuit Protection

Main/Relay Power Fuse	F1	5x20mm	6 Amp	Littelfuse O234006P
Power Supply/CPU Fuse	F2	5x20mm	0.25 Amp	Littelfuse O218.250P

Other

Dimensions	7" tall, 7" wide, 4" deep. Nema 4X Polycarbonate Hinged Enclosure.
Weight	2.7 lb.
Environment	0-50°C, 10-90%RH (non-condensing)

Figure 1. Simplified Schematic

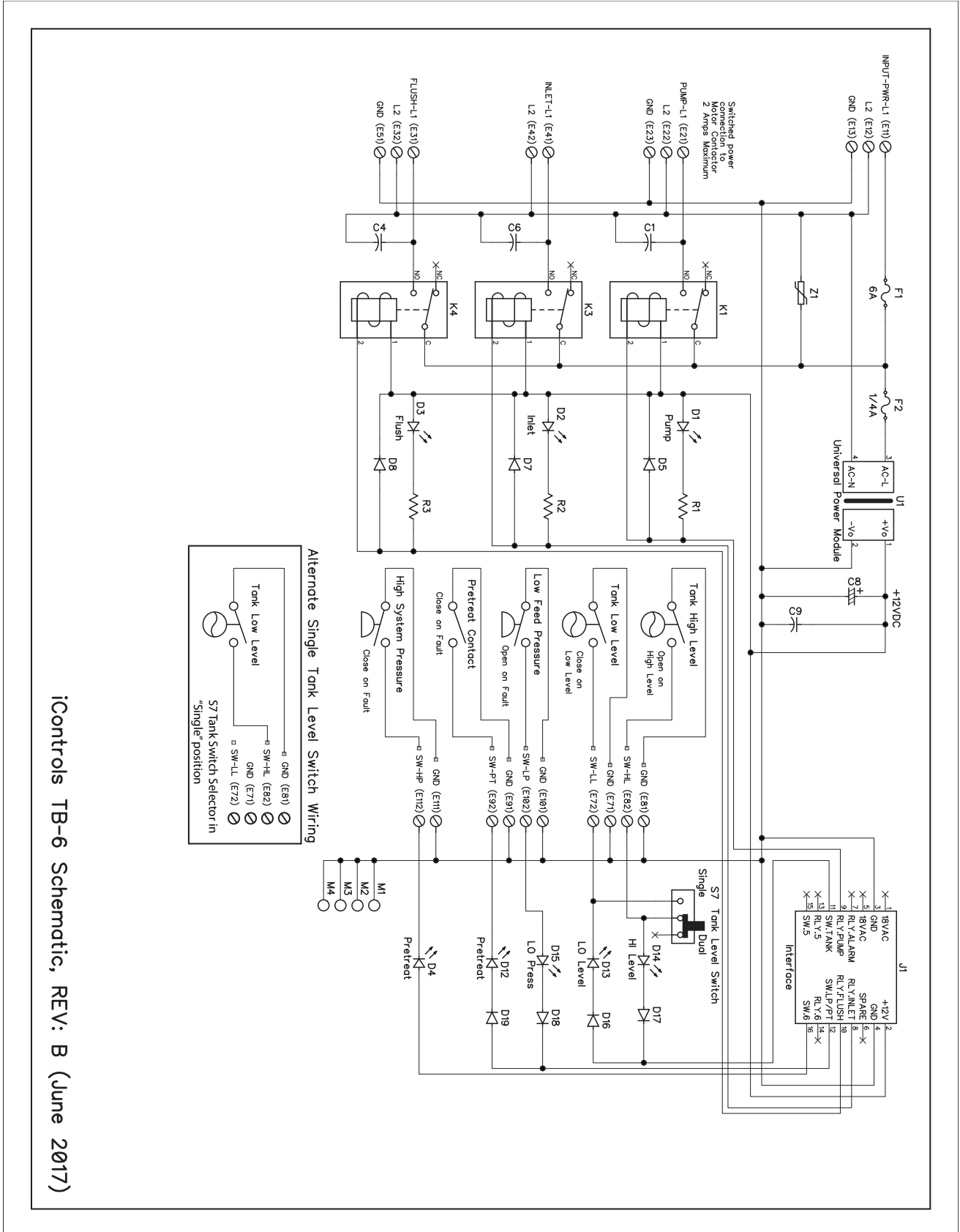

iControls TB-6 Schematic, REV: B (June 2017)

Figure 1.1 Field Wiring Diagram

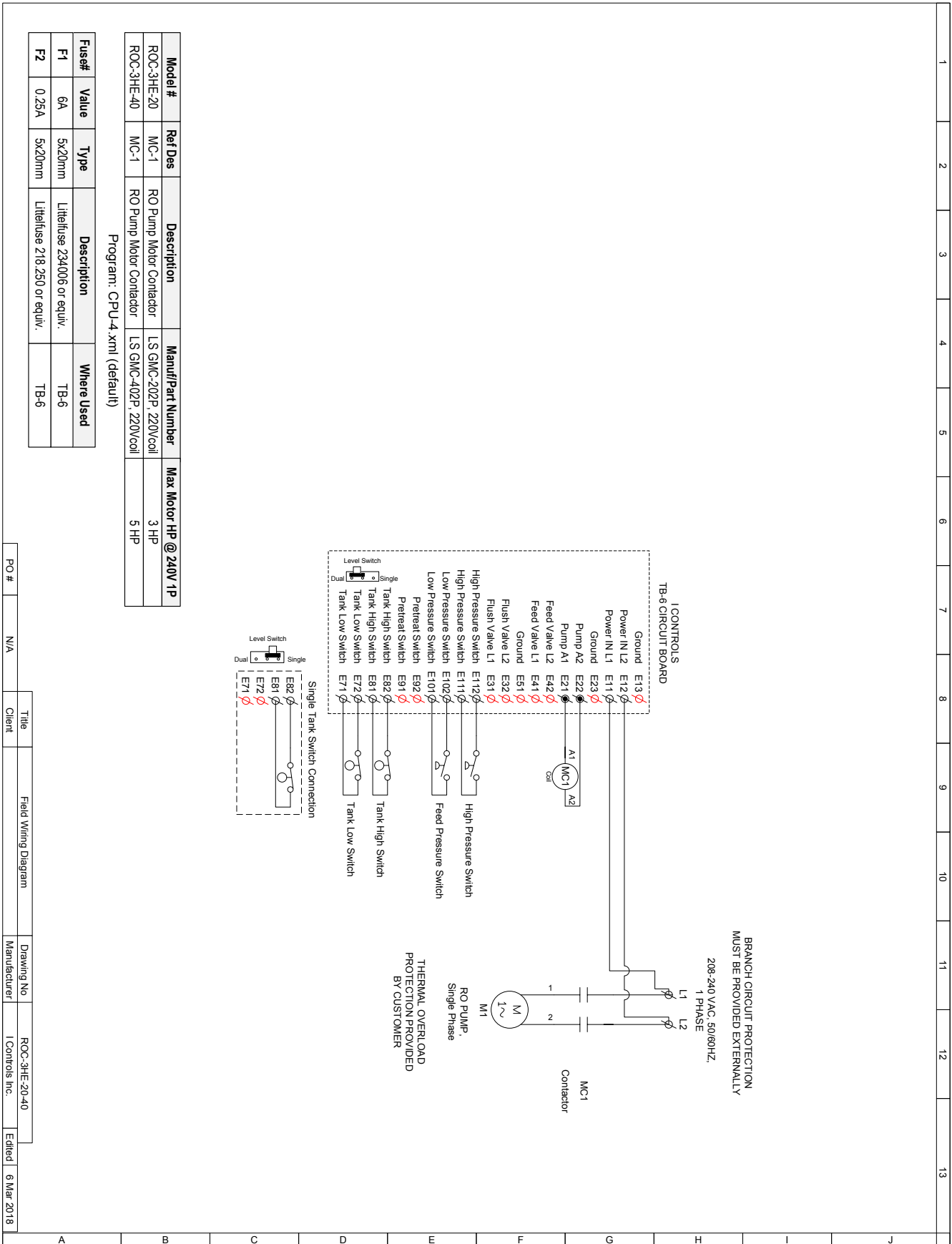

PO #	N/A	Title	Field Wiring Diagram	Drawing No	ROC-3HE-20-40	Edited	6 Mar 2018
		Client		Manufacturer	iControls Inc.		

Figure 2. Controller Overview

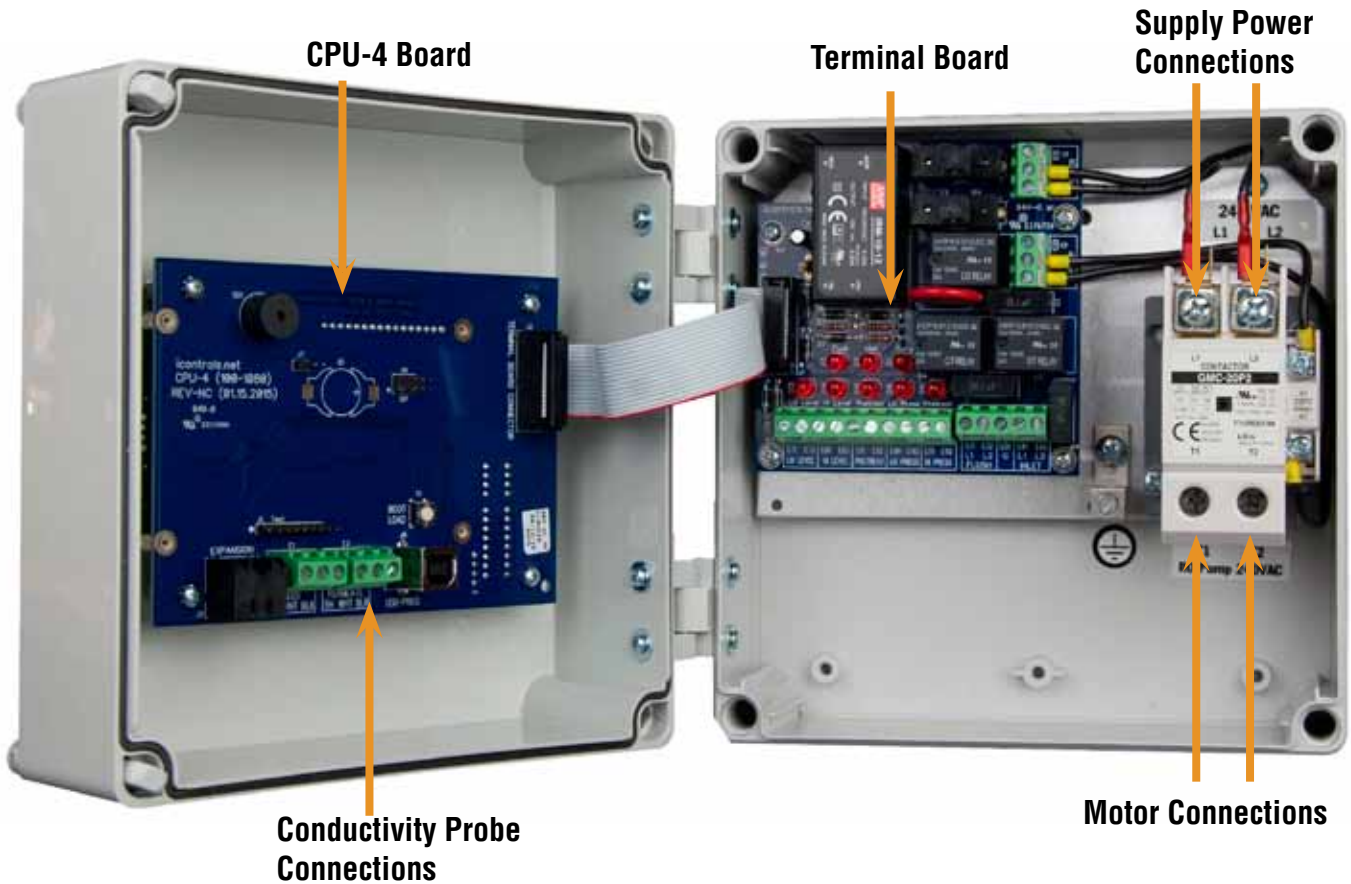
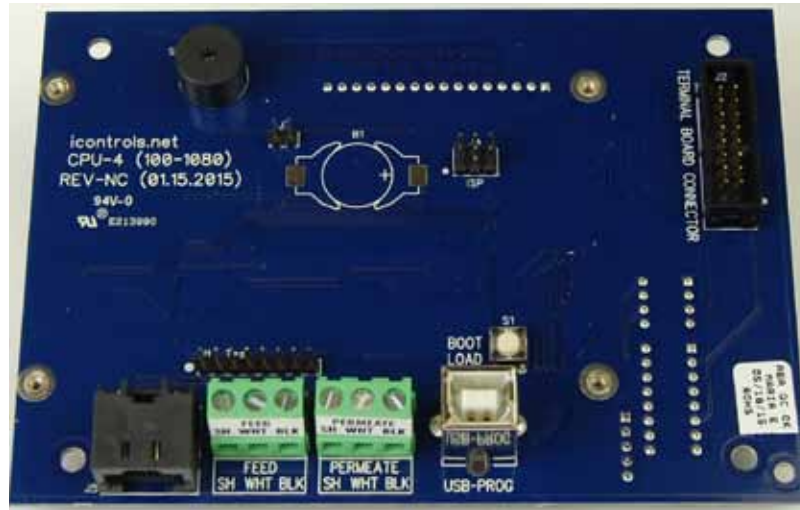

Figure 3. Controller Detail: CPU-4

Typical Configuration



Detailed View

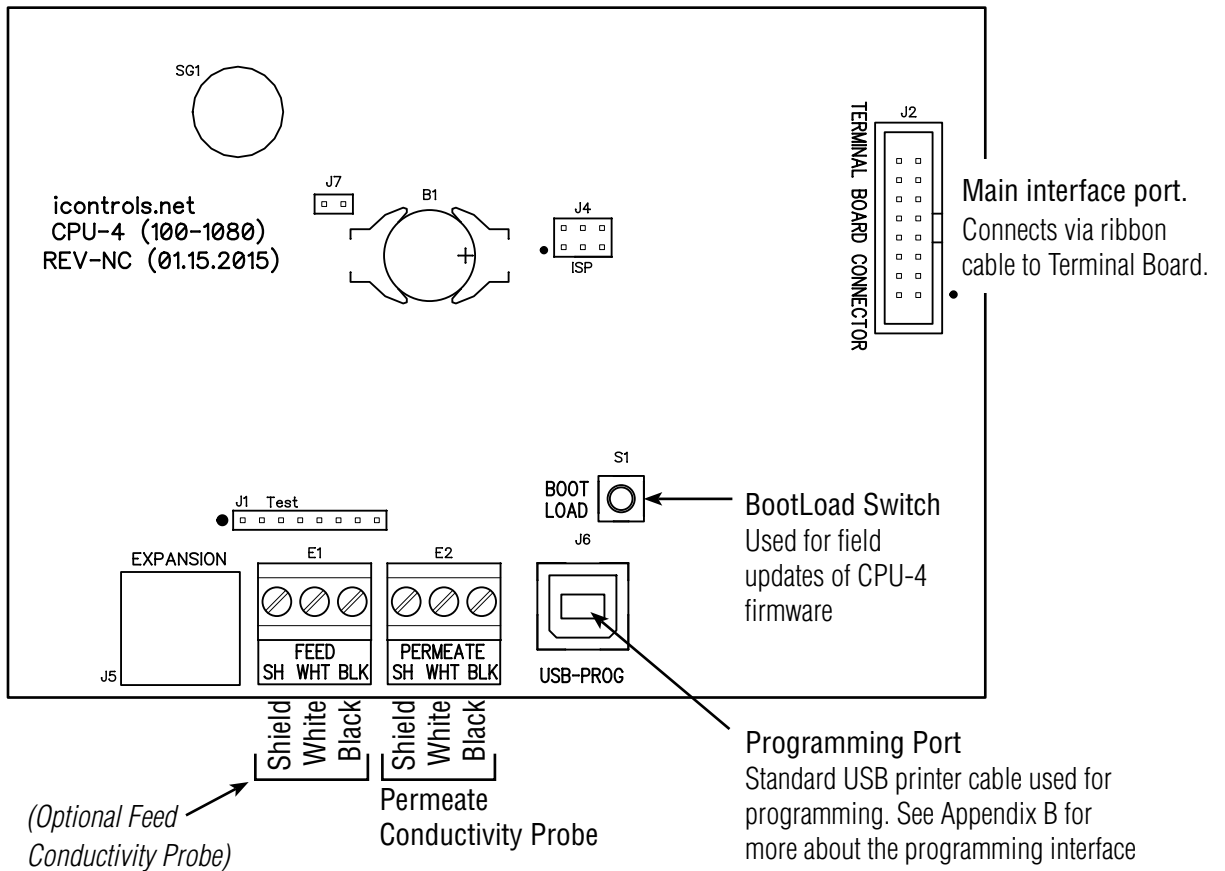

Figure 4. Controller Detail: Terminal Board, TB-6 (See Fig. 1 for schematic)



Tank Switch Selector
Selects single or dual switch modes

Inlet, Flush and Pump LEDs
Illuminate when the relay is energized.

Switch LEDs
Illuminate when switches close.

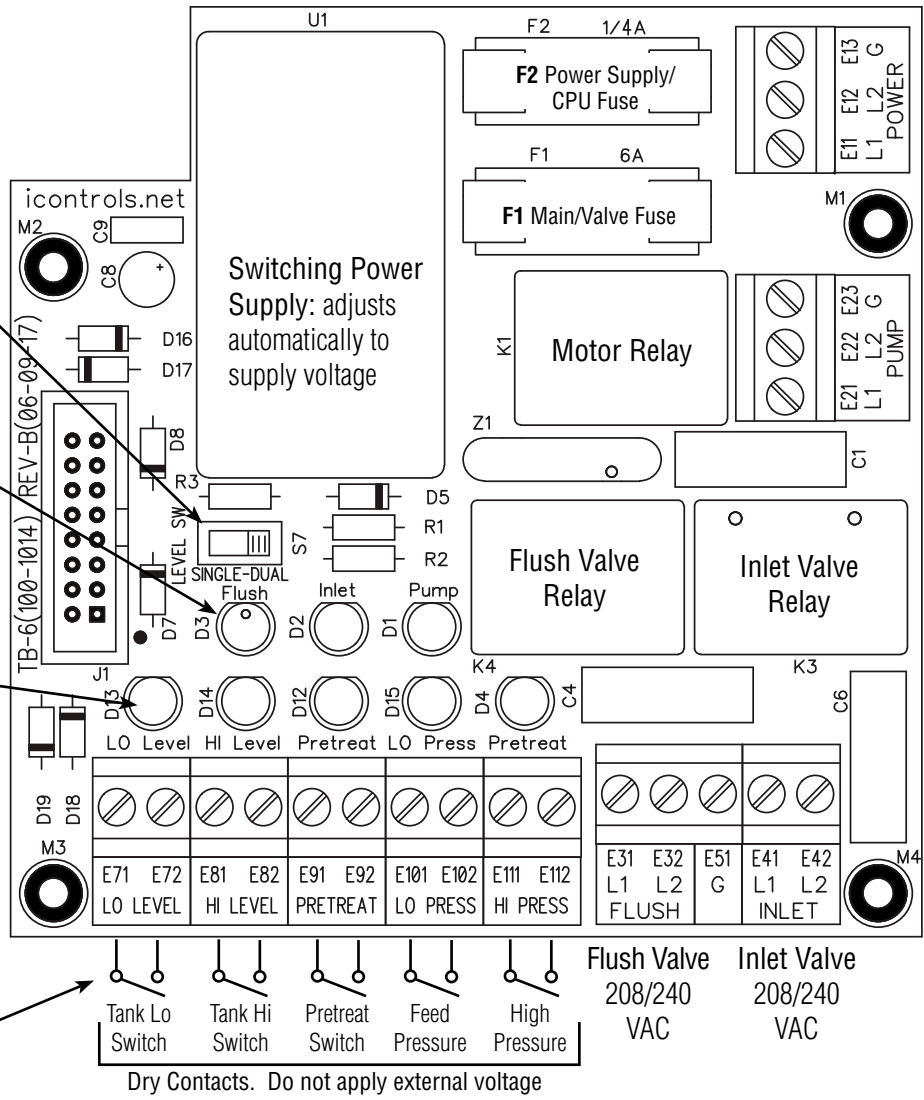

Supply Power
208/240 VAC

Contactor Coil
208/240 VAC

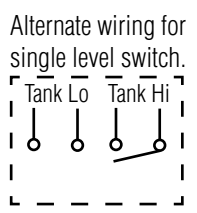
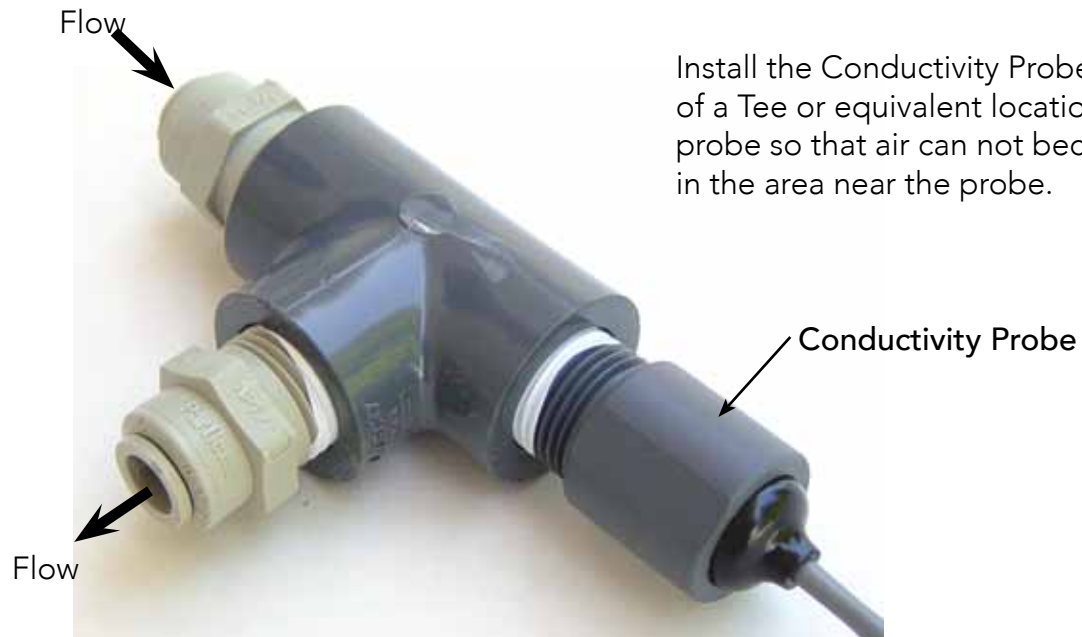

Figure 5. Conductivity Probe Installation

Install the Conductivity Probe in the "Run" of a Tee or equivalent location. Orient the probe so that air can not become trapped in the area near the probe.

Figure 6. Controller Programming. Accessing the hidden menus.

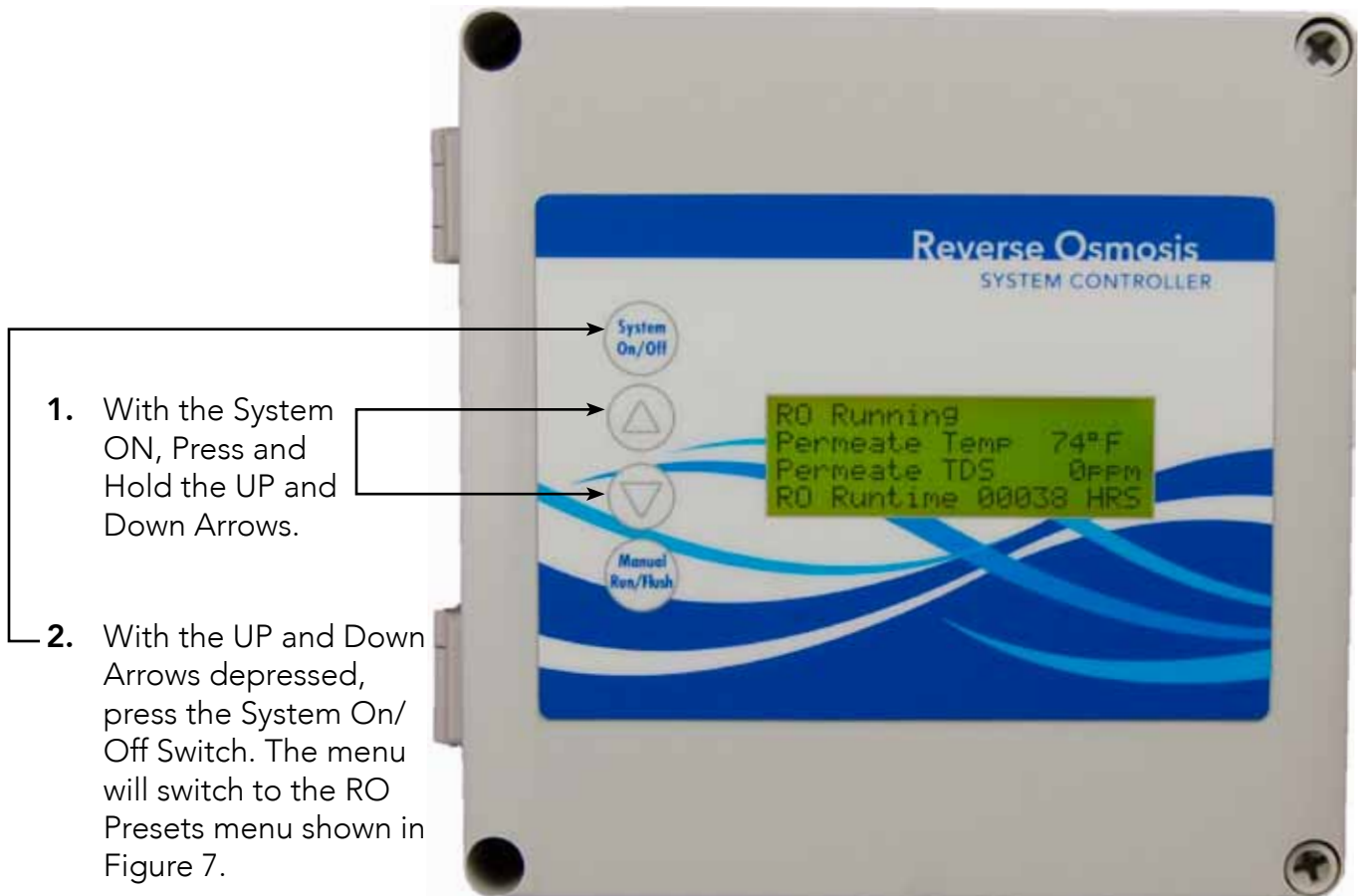

Table 2. Controller Programming: ROC-3HE Program Selections

The controller has 4 separate user-selectable sets of settings for configuring the RO. The factory default settings are shown below. The settings are identical except for variations in the flush behavior.

- **Program 1, High Pressure flush.**
- **Program 2, No Flush**
- **Program 3, Permeate Flush, (low pressure, inlet valve closed)**
- **Program 4, Low Pressure, feed water flush**
- See the previous page for instructions on how to access the menu for selecting these programs.
- See Appendix A for a detailed explanation of the Parameters and their affect on the RO's operation.

Parameter	Value	Program 1	Program 2	Program 3	Program 4
Tank Level Switch delay (actuation and de-actuation)	Seconds	2	2	2	2
Pressure Switch delay (actuation and de-actuation)	Seconds	2	2	2	2
Pretreat Switch delay (actuation and de-actuation)	Seconds	2	2	2	2
Pump start delay	Seconds	10	10	10	10
Inlet Solenoid stop delay	Seconds	1	1	1	1
Pump start retry interval (restart delay after LP fault)	Seconds	60	60	60	60
Low pressure fault shutdown, # of faults	Faults	5	5	5	5
Low pressure fault shutdown, time period to count faults	Minutes	10	10	10	10
Low pressure fault shutdown, reset after shutdown	Minutes	60	60	60	60
Low pressure timeout fault	Seconds	60	60	60	60
Flush Behavior		High Pressure	No Flush	Permeate Flush	Low Pressure Flush
Startup Flush: Minutes from last flush	Minutes	0	0	0	0
Startup Flush: Duration	Seconds	0	0	0	30
Periodic Flush: Interval	Minutes	60	0	0	0
Periodic Flush: Duration	Seconds	30	0	0	0
Shutdown Flush: Time from last flush	Minutes	10	0	0	0
Shutdown Flush: Minimum operation	Minutes	30	0	0	0
Shutdown Flush: Duration	Seconds	60	0	60	60
Idle Flush: Interval *	Minutes	0	0	0	0
Idle Flush: Duration *	Seconds	0	0	0	0
Timed Manual Run	Minutes	5	5	5	5
Timed Manual Flush	Minutes	5	0	5	5

* These features are disabled by default due to the potential for confusion on the part of end-users in the field. They can be enabled when needed via the OEM PC programming interface which allows changes to all of the values shown above.

Appendix A. Controller Programming: Parameters Explained

Parameter	Value	Range	Example
Input Switch Behaviors			
Tank Level Switch delay (actuation and de-actuation)	Seconds		2.0
<i>This specifies the time that the tank switch must be closed or open before the controller accepts it as a valid condition. The function is to prevent nuisance tripping of the RO especially in small tanks or turbulent tanks</i>			
Pressure Switch delay (actuation and de-actuation)	Seconds		3
<i>This specifies the time that the pressure switch must be closed or open before the controller accepts it as a valid condition. Since pressure switches usually have built-in hysteresis this value is set at 0.</i>			
Pretreat Switch delay (actuation and de-actuation)	Seconds		2
<i>This is the time that the pretreat switch must be OPEN before the controller accepts it as a valid condition.</i>			
Pump/Inlet Solenoid Behaviors			
Pump start delay	Seconds		10
<i>On RO start-up, after the tank switch opens, the inlet solenoid valve is energized. When the inlet pressure switch closes this begins the "Pump start delay". If the pressure switch remains closed, the pump will start after 10 seconds.</i>			
Inlet Solenoid stop delay	Seconds		1
<i>This value sets the delay for the inlet solenoid valve to be deenergized following the deenergizing of the motor on RO shut down. The purpose is to prevent the pump from operating against a closed suction as the pump spins down.</i>			
Low Inlet Pressure Behaviors			
Pump start retry interval (restart delay after LP fault)	Seconds		60
<i>When the inlet pressure switch opens, the controller deenergizes the motor and the inlet solenoid valve remains open. The controller will continue to monitor the inlet pressure switch. After the switch is closed for the duration of the "Pump start retry interval" the motor is reenergized.</i>			
Low pressure fault shutdown, # of faults	Faults		5
Low pressure fault shutdown, time period to count faults	Minutes		10
Low pressure fault shutdown, reset after shutdown	Minutes		60
<i>These three values work together to determine how the RO handles Low Pressure conditions. The first two values, "# of faults" and "time period to count faults", sets the limit for the number of low fault conditions over time that are required to place the RO in "Low Pressure Fault Shutdown". The third value sets the duration of the "Low Pressure Fault Shutdown" which is the period that the RO will remain idle before trying to restart. The purpose of the Low Pressure Fault Shutdown is to prevent an RO from turning OFF/ON repeatedly without any limit.</i>			
Low pressure timeout fault	Seconds		60
<i>If the inlet valve is open, but the pressure isn't sufficient to close the inlet pressure switch, the RO would run indefinitely on line pressure. This value sets the time limit for the RO to operate with the inlet valve open with Low Pressure as indicated by an Open inlet pressure switch before a Low Pressure Fault is added to the counter above</i>			

Appendix A. Controller Programming: Parameters Explained

Flush Behavior			
Time from last flush before Flush on Shutdown	Minutes		15
Minimum operation before Flush on Shutdown	Minutes		60
Flush duration on Shutdown	Seconds		60
Periodic Flush interval	Minutes		60
Periodic Flush duration	Seconds		30
Unit Idle Flush interval *	Minutes		0
<i>The Unit Idle Flush Interval sets a time after which the RO will start-up and run in the flush mode. This is disabled by default because of the danger of over-flowing a tank if not properly implemented. It is intended for environments where leaving the RO idle for long periods would invite bio-fouling. (0)=disabled</i>			
Unit Idle Flush duration *	Seconds		0
<i>Sets the duration of the Idle Flush. (0)=disabled</i>			
Timed Manual Run - Duration of Manual Run	Minutes		5
Timed Manual Flush - Duration of Manual Flush	Minutes		5
Conductivity Probe Sample Rate	Seconds		2
Conductivity Shutdown * (0)=disabled	Minutes		0

Controller Fault Condition Displays

Below are examples and explanations of the displays which accompany the fault conditions possible on the CPU-4. Fault conditions always indicate a problem of some sort which requires corrective action. the displays provide sufficient information to recognize the source of the fault and the required corrective action.

Low Pressure Fault: *(System is responding to low pressure condition per system settings)*

- Line 1 "Service Fault"
- Line 2 "Low Feed Pressure"
- Line 3
- Line 4 "Restart in MM:SS"

Pre Treat Fault: *(Pretreat Switch is closed indicating problem with pretreat system).*

- Line 1 "Service Fault"
- Line 2 "Pretreat"
- Line 3
- Line 4 "Check Pretreat Sys."

Permeate Conductivity Fault: *(Permeate conductivity is higher than the alarm setpoint.)*

- Line 1 "Service Fault"
- Line 2 "Permeate TDS xxx ppm" or "Permeate Cond xxx uS"
- Line 3 "Alarm SP xxx ppm" or "Alarm SP xxx uS"
- Line 4 "To Reset Push OFF/ON"

Feed Conductivity Fault: *(Feed conductivity is higher than the alarm setpoint.)*

- Line 1 "Service Fault"
- Line 2 "Feed TDS xxx ppm" or "Feed Cond xxx uS"
- Line 3 "Alarm SP xxx ppm" or "Alarm SP xxx uS"
- Line 4 "To Reset Push OFF/ON"

Conductivity Probe Error messages:

- Line 2 "Over-range" - Measurement is out of range for the circuit, probe may also be shorted
- Line 2 "Probe shorted" - Short circuit detected on temperature sensor in probe
- Line 2 "Probe not detected" - Open circuit detected on temperature sensor in probe (white and unshielded wire)
- Line 2 "Probe Startup 1" - Internal reference voltage too high to make valid measurement
- Line 2 "Probe Startup 2" - Internal reference voltage too low to make valid measurement
- Line 2 "Probe Startup 3" - Internal excitation voltage too high to make valid measurement
- Line 2 "Probe Startup 4" - Internal excitation voltage too low to make valid measurement

Appendix B. Controller Programming: Programming Interface Overview

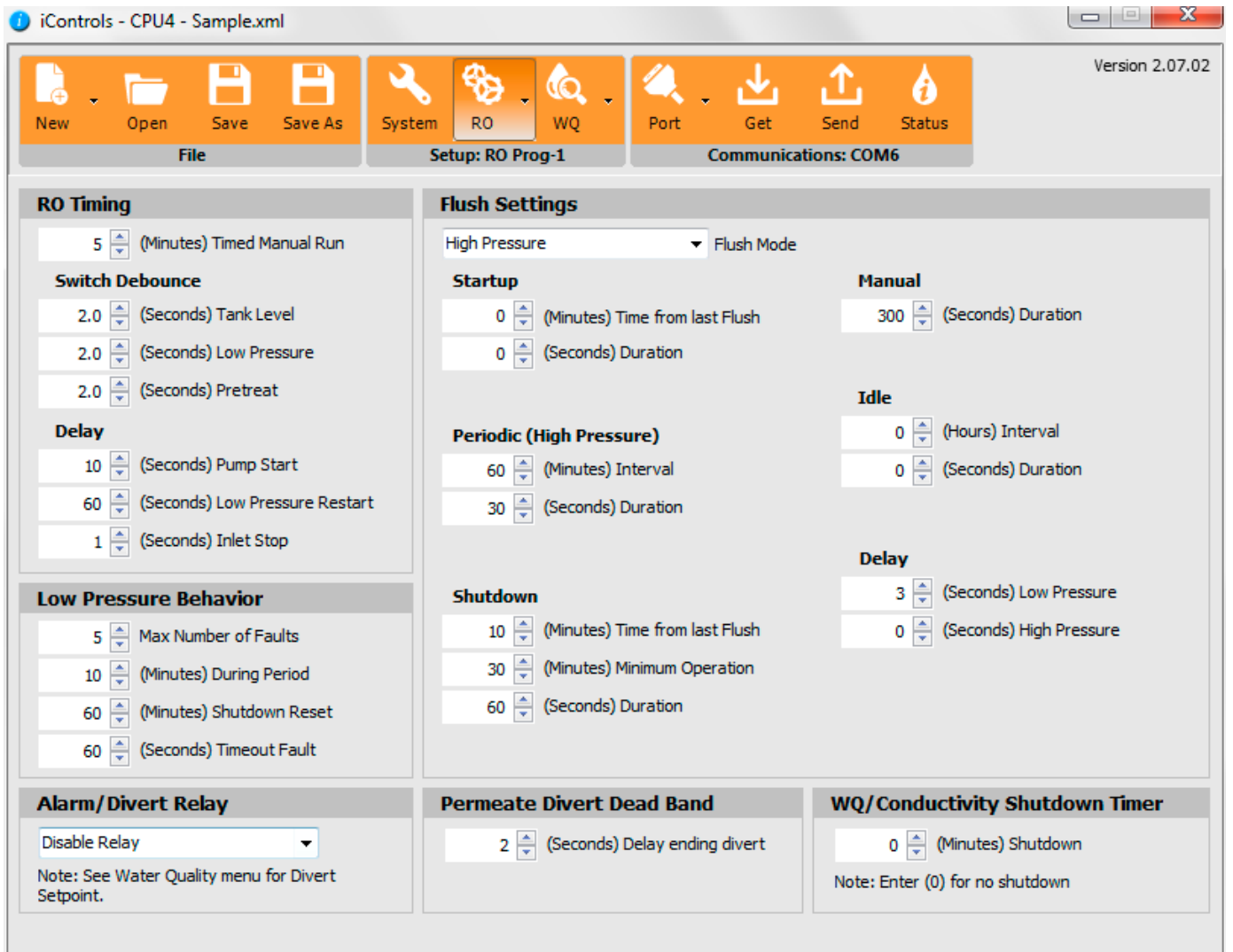

The Programming interface is a Windows-based tool for making changes to the ROC software. This screen shows the RO settings available. There are 4 field-selectable sets of settings stored in the CPU-.4

Appendix C. Warranty

iControls Limited Warranty

What the warranty covers:

iControls warrants the ROC-3HE to be free from defects in materials and workmanship during the warranty period. If a product proves to be defective during the warranty period, *iControls* will at its sole option repair or replace the product with a like product. Replacement product or parts may include remanufactured or refurbished parts or components.

How long the warranty is effective:

The ROC-3HE is warranted for one (1) year for parts and labor from the date of the first consumer purchase or 15 months from ship date, whichever comes first.

What the warranty does not cover:

1. Damage, deterioration or malfunction resulting from:
 - a. Accident misuse, neglect, fire, water lightning or other acts of nature, unauthorized product modification or failure to follow instructions supplied with the product.
 - b. Repair or attempted repair by anyone not authorized by *iControls*
 - c. Any damage of the product due to shipment.
 - d. Causes external to the product such as electric power fluctuations.
 - e. Use of supplies or parts not meeting *iControls*' specifications.
 - f. Normal wear and tear.
 - g. Any other cause which does not relate to a product defect.
2. Transportation costs necessary to obtain service under this warranty.
3. Labor other than factory labor.

How to get service:

1. To obtain warranty service, contact *iControls* for a Return Material Authorization (RMA).
2. You will be required to provide:
 - a. Your name and address
 - b. A description of the problem
3. Package the controller carefully for shipment and return it to *iControls*, freight prepaid.

Limitation of implied warranties:

There are no warranties, expressed or implied, which extend beyond the description contained herein including the implied warranty of merchantability and fitness for a particular purpose.

Exclusion of damages:

iControls' liability is limited to the cost of repair or replacement of the product. *iControls* shall not be liable for:

1. Damage to other property caused by any defects in the product, damages based upon inconvenience, loss of use of the product, loss of time, loss of profits, loss of business opportunity, loss of goodwill, interference with business relationships or other commercial loss, even if advised of the possibility of such damages.
2. Any other damages, whether incidental, consequential or otherwise.
3. Any claim against the customer by any other party.

Effect of state law:

This warranty gives you specific legal rights, and you may also have other rights which vary from state to state. Some states do not allow limitations on implied warranties and/or do not allow the exclusion of incidental or consequential damages, so the above limitations and exclusions may not apply to you.