

MicroLinx Series L

Electronic Metering Pump



Product Manual



Important Safety Instructions

Read all warnings and instructions in this manual.
Save all instructions.



Intertek

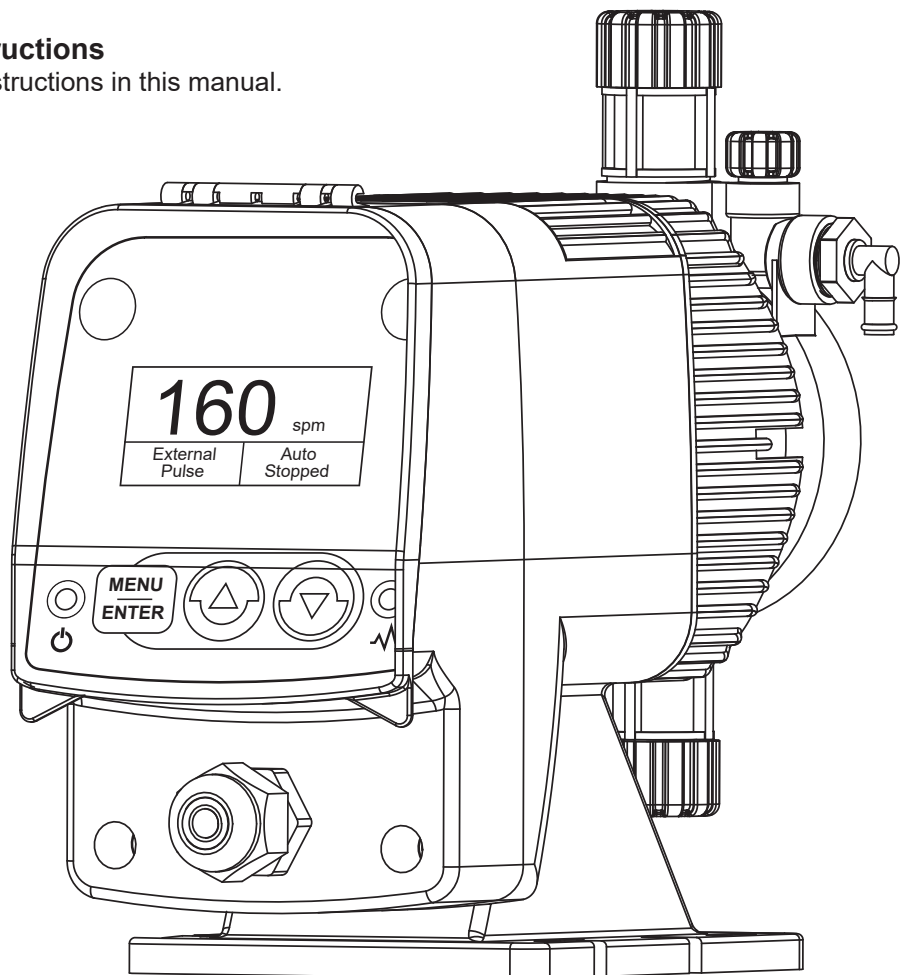

Advantage Controls
4700 Harold-Abitz Dr.
Muskogee, OK 74403
Phone: (918) 686-6211
Fax: (888) 686-6212
www.advantagecontrols.com
support@advantagecontrols.com

17/2025

Table of Contents

- Introduction 3
- Model Numbering..... 3
- Unpacking 4
- Safety Considerations..... 4
- Installation..... 5
- Start-Up..... 7
- Control Methods..... 7
- Optional Features 7
- Menu Navigation..... 8
- Wifi Connection..... 14
- External Signal Cable Wiring 18
- Liquid End Diagram 19
- Replacement Parts 20
- Maintenance 21
- Trouble Shooting..... 22
- Output Curves..... 23

Manufacturer’s Product Warranty

Advantage Controls warrants units of its manufacture to be free of defects in material or workmanship. Liability under this policy extends for 24 months from date of installation. Liability is limited to repair or replacement of any failed equipment or part proven defective in material or workmanship upon manufacturer’s examination. Removal and installation costs are not included under this warranty. Manufacturer’s liability shall never exceed the selling price of equipment or part in question. Advantage disclaims all liability for damage caused by its products by improper installation, maintenance, use or attempts to operate products beyond their intended functionality, intentionally or otherwise, or any unauthorized repair. Advantage is not responsible for damages, injuries or expense incurred through the use of its products.

The above warranty is in lieu of other warranties, either expressed or implied. No agent of ours is authorized to provide any warranty other than the above.

30 Day Billing Memo Policy

Advantage Controls maintains a unique factory exchange program to ensure uninterrupted service with minimum downtime. If your unit malfunctions, call 1-800-743-7431, and provide our technician with Model and Serial Number information. If we are unable to diagnose and solve your problem over the phone, a fully warranted replacement unit will be shipped, usually within 48 hours, on a 30-Day Billing Memo.

This service requires a purchase order and the replacement unit is billed to your regular account for payment. The replacement unit will be billed at current list price for that model less any applicable resale discount. Upon return of your old unit, credit will be issued to your account if the unit is in warranty. If the unit is out of warranty or the damage not covered, a partial credit will be applied based upon a prorated replacement price schedule dependent on the age of the unit. Any exchange covers only the controller or pump. Electrodes, liquid end components and other external accessories are not covered.

Introduction

This manual covers all facets of operation of the Advantage MicroLinx pump, including unpacking, mounting, electrical and plumbing connection, and start-up. Safety, maintenance and repair, warranty, and factory information is also provided. Please read this manual completely before proceeding. Observe safety protocols and heed all warnings and precautions.

Model Numbering

MicroLinx Series L pump model numbers define the output, pressure and control functions present on a particular pump. Your pump may be supplied with one or more of the options described in this manual. To determine what features apply to your pump, check the model number label located on the pump.

Model Number Example

L 30 X 1 – K E C 1

Output

- 05** = 5 GPD (18.9 LPD) at 300 PSI (20.6 bar)
- 12** = 12 GPD (45.4 LPD) at 250 PSI (17.2 bar)
- 15** = 15 GPD (56.7 LPD) at 150 PSI (10.3 bar)
- 30** = 30 GPD (113.5 LPD) at 100 PSI (6.8 bar)
- 45** = 45 GPD (170.3 LPD) at 75 PSI (5.1 bar)

Control

- X** = Speed adjustment with timers, pulse, & mA in
- P** = 5 VDC power for flowmeters

Voltage

- 1** = 120 vac, USA plug and agency approvals
- 2** = 120-220 vac, no plug

Pump Head Material

- K** = Kynar **D** = Kynar degassing head
- S** = 316 Stainless

Seat Material

- V** = Viton
- F** = Teflon
- H** = Hypalon

Check Ball

- C** = Ceramic
- S** = Stainless

Tubing Connections

- 1** = 3/8" tubing rated to 200 PSI (13.7 bar)
- 2** = 1/4" tubing rated to 300 PSI (20.6 bar)
- 4** = 1/4" black UV tubing rated to 300 PSI (20.6 bar)
- R** = 1/4" FNPT
- U** = 3/8" black UV tubing rated to 200 PSI (13.7 bar)
- V** = 3/8" tubing rated to 200 PSI (13.7 bar) with clear suction

- NOTES:**
1. Tubing selection may impact pump rating.
 2. This list represents our most popular options. If you have an option not covered, contact the factory or your dealer for more details.

Unpacking

The MicroLinx pump has been shipped as a complete package, ready for installation. If the shipping carton shows any signs of damage, notify the shipping company immediately upon receipt. Advantage Controls cannot be held responsible for damage from shipping.

Unpack the carton and insure the following items are present:

1. Metering pump
2. Suction, discharge and priming tubing
3. Foot valve and weight
4. Injection fitting
5. MLCABLE-7P7 input signal cable
6. Instruction sheet

Safety Considerations



Installation Location

Select a mounting location convenient to the chemical supply and power for the pump that will not flood. The ambient temperature should not exceed 120 degrees F (50°C). Higher temperatures will affect the output and life of the pump. Do not use the standard poly tubing in direct sunlight.

Liquid Compatibility

Always refer to the solution supplier for compatibility of your specific model metering pump. Contact your supplier or local Advantage Controls distributor for further information.

Protective Clothing

Always wear protective clothing, face shield, safety glasses and gloves when working on or near a metering pump. Refer to solution's SDS precautions from your solution supplier.

Water Pre-Prime and Testing

All pumps are pre-primed with water when shipped from the factory and some water may be present. All UL electrical safety evaluations performed with water only.

Tubing and Piping Connections

Pumps use carefully matched components to achieve a predictable metering output. This can only be maintained if all fitting sizes remain unaltered. All tubing connections should be hand-tightened 1/8 - 1/4 turn after the fitting is snug to provide a leak-proof seal. Most pumps have straight threads on the head and fittings and are sealed by the O-rings. Excessive overtightening or use of a pipe wrench can cause damage to the fittings, seals, or pump head. DO NOT use PTFE tape or pipe dope to seal threads. PTFE tape may only be used on the 1/2" NPT thread side of the Injection Check Valve and the stainless-steel liquid end connections.

Discharge Tubing Length

There is an approximate 2.5 psi capability lost for every 1 foot of vertical rise of the discharge tubing to the injection point. It is recommended that all discharge tubing be shielded to prevent possible injury in case of rupture or accidental damage. If tubing is exposed to sunlight, black UV resistant tubing should be installed. Check tubing frequently for cracks and replace as necessary.

Clear Vinyl Tubing

Pump may come with a roll of clear flexible vinyl tubing; it is not intended for pressurized use. It is only for connection to suction and prime return lines of the pump head and must not be used as discharge tubing.

Plumbing

Always adhere to your local plumbing codes and requirements. Check local plumbing codes for guidelines. Advantage Controls is not responsible for improper installations. If you are pumping downhill or into low or no system pressure, a back pressure/anti-syphon device such as Advantage's Three Function Valve should be installed to prevent over pumping or syphoning. Contact your Advantage Pump representative.

Retightening Components

Plastic materials may exhibit creep characteristics when under pressure over time. To insure a proper fit it may be necessary to retighten the head bolts and tubing connections periodically.

Electrical Connections

To reduce the risk of electrical shock, the metering pump must be plugged into a properly grounded, grounding-type receptacle with ratings conforming to the data on the pump control panel. The pump must be connected to a good ground. **DO NOT USE ADAPTERS!** All wiring must conform to local electrical codes.

Ground Fault Circuit Interrupter

To reduce the risk of electric shock, install only on a circuit protected by a Ground Fault Circuit Interrupter (GFCI).

Installation

Suction Lift Installation

Mount the pump around the top of the solution tank, not to exceed 5 feet from pump to bottom of tank.

Flooded Suction

This installation is recommended for very low outputs, solutions that gasify and/or high viscosity solutions. Priming is easier and loss of prime is reduced. Failure of the pump diaphragm or rupture of the solution tubing can cause loss of solution in the tank.

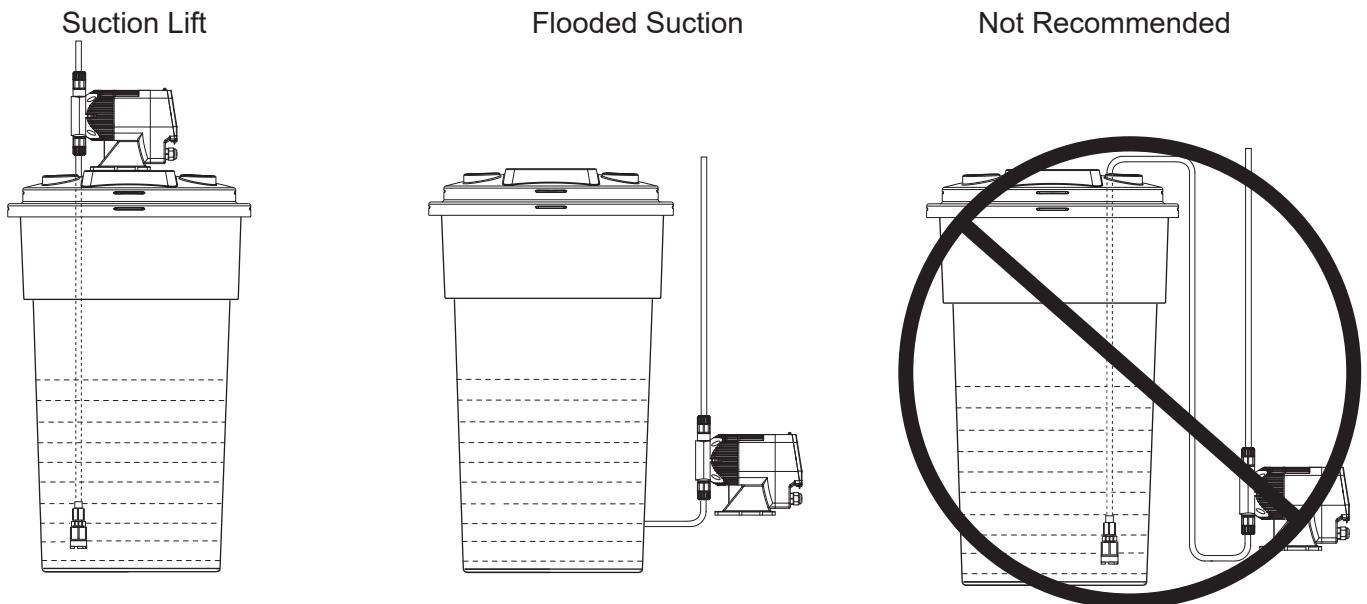

Wall Mounting

The fluid end portion (head assembly) of the pump is set up to accommodate mounting of the pump to the solution container, either as a flooded suction, or a suction lift. The pump head must be kept in a vertical position for proper operation. The head can be removed and rotated 90° if needed to keep the inlet and outlet valves in a vertical position.

Foot Valve Installation

A weight is provided to hold the tubing and foot valve in a vertical position at the bottom of the tank. **Do not allow the foot valve to lay horizontally in the container.** This defeats the action of the valve and causes the pump to lose prime. Keep suction tubing reasonably short and avoid high spots or bends.

Injection Valve Installation

The injection valve is designed to prevent a back flow and to inject solution into the line. To work properly, this valve must be mounted within 45° of vertical (see drawing). One end of the injection valve is 1/2" MNPT. Install this end into the piping system. Connect the pump's discharge tubing to the opposite end of the injector.

When installation is made into a line with zero pressure or when pumping into an open vessel, use the optional three function injection valve which provides back pressure and anti-syphon capabilities.

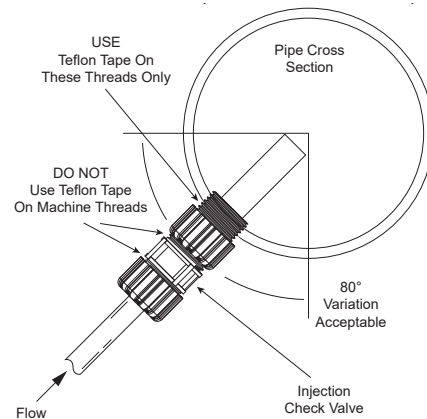

Optional Three Function Valve

The optional 3-function injection valve assembly provides anti-siphoning for metering of liquids “downhill” or into the suction side of a circulating pump. It provides protection against an accidental application of suction pressure at the fluid injection point. Its Teflon coated diaphragm provides a positive anti-siphon action. It also provides back pressure to permit metering into atmospheric discharge (open container) without overpumping.

Priming Valve Connection

Connect the clear poly tubing to the outlet of the bleed or priming valve. Position the free end of this tube in the solution container. Standard head configurations include a priming valve built into the head. Clear poly tubing should be connected to the outlet of this valve, the other end of the tube should be placed in the container above the fluid level.

Tubing Nut Connections

Do not overtighten the tubing connectors. Tighten the fittings no more than 1/4 turn after the fitting contacts the seal. Hand tighten only. **Do not use a wrench or pliers** as they may damage the fittings. Do not use Teflon tape except on NPT fittings. **WARNING: Clear flexible tubing is not intended for pressurized use.**

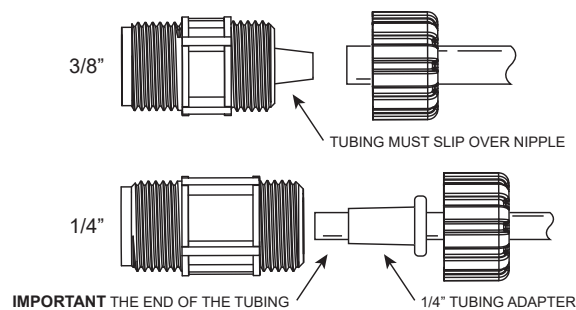

Start-Up

Priming the Pump

Plug in pump. Set the strokes per minute to maximum speed (see 2.2 Manual section on pg 9). While pump is operating, if fluid begins moving, no further priming is required. If fluid is not moving, open bleed valve approximately one turn until fluid begins to move. When suction line fills, close bleed valve. Do not over tighten bleed valve or damage may occur.

Adjusting Feed Rate

The model L allows for exact setting of the pumps stroking rate (speed) via the keypad or a wifi connection. Standard strokes per minute settings available are: 0-200 strokes per minute.

Calculating Output

A pump's output per minute can be determined by dividing the maximum rated gallons per day by 1440 (minutes per day). For example, a 30 gallons per day (gpd) pump at a maximum speed setting of 200 strokes per minute (spm) will pump 0.000104 gallons per stroke (gps).

$$30 \div 1440 = 0.0208 \text{ gpm} \div 200 \text{ spm} = 0.000104$$

With this value and the pump's speed setting (strokes per minute) you can calculate your pump's output at it's rated pressure. A 30 gpd pump set at 50 strokes per minute:

$$50\text{spm} \times .000104\text{gps} \times 1440 \text{ (minutes per day)} = 7.49 \text{ gallons per day}$$

Note: Output curves are listed at the back of this manual.

Control Methods

The Series L pump comes standard with several different methods of control that can be selected and configured in the menu. There is also an external auto-stop input that will force the pump off regardless of the defined control method.

MANUAL – Pump will run at the user defined speed as long as it has power with no auto-stop signal

MULT/DIV – Pump's speed is driven by an incoming pulse or dry contact from a flowmeter. The pump can stroke MULTiple times per one incoming contact or it can DIVide the incoming pulses to stroke one time based on the user defined settings.

mA IN – Pump's speed is driven by an incoming 4-20mA signal. A speed rate can be defined for a 4 and 20mA reading and the pump will automatically scale it's speed proportionally between those to settings based on the incoming signal.

TIMERS – The pump can be activated based on the settings of four different types of timers:

- Water Meter (WM) timer will run the pump for a defined amount of time after a defined amount for flow volume is received on the pulse or water meter input.
- Recycle timer will continuously turn the pump on for the defined ON Cycle time then off for the defined OFF Cycle time.
- 28 -Day timer allows the pump to be activated at specific times of defined days and weeks over a 28 day cycle.
- Batch timer allows the pump to run one time for a defined time each time it is manually activated.

Optional Features

Degassing Head

Pumps with the PVDF degassing head option have a different priming valve that includes a check ball and viton seat. This valve constantly allows any air trapped in the head to vent out of the priming return tubing to the tank. A small amount of the pump's total output may be lost back to the tank.

No adjustment to the degass valve is typically needed but a half turn counter clockwise will vent the head and allow for a fast prime if needed. The degassing valve must then be reseated but not over tightened for proper operations.

Menu Navigation

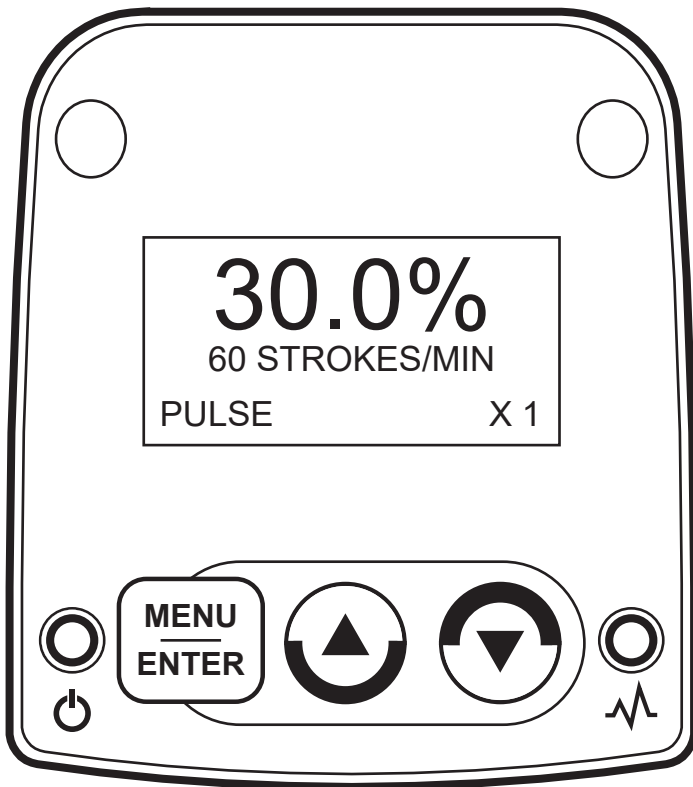

MENU / ENTER - Used to confirm choices as well as enter the config screen from the run status screen.



UP / DOWN arrows - Used to adjust values as well as navigate to other menu categories.



POWER indicator - Will be solid "green" when power is supplied to the pump.



STATUS indicator - Will flash "red" on each stroke when pump is running.

To access the menus press the Menu / Enter key on the front panel. This takes you out of the run status screen and into the Configure menu. The MicroLinx Series L menus are easily navigated by pressing the arrow keys and confirming selection with the Menu / Enter key. A flashing box is similar to positioning a computer mouse over a link and the Menu / Enter button will act as a mouse click.

FLASHING = Highlighted, SOLID = Selected

Some options will have separate screens and some values will change on the same screen. Exit / Save will need to be selected to confirm some changes.

Note: All pump settings can be edited with the AirAdvantage app / Wifi interface. See Wifi section.

1. Run Mode / Status Screen

Displays the run mode, status, and current values.

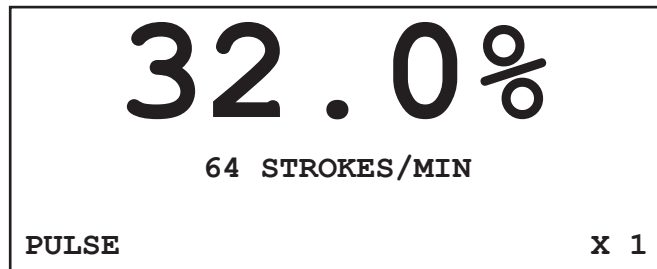

Tip: Manual mode will allow you to use the arrow keys to increase & decrease these values while on this screen.

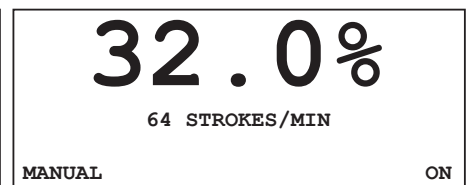
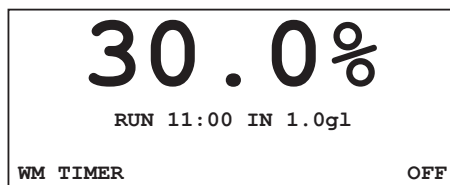

2. Config Menu

OFF	TIMERS
MANUAL	CLOCK SET
MULT/DIV	PASSWORD
mA IN	WIFI-ON

This is the main configuration menu. Use the Up/Down arrows (while selection choice is flashing) to change to a different menu. Press Menu/Enter to confirm selection.

OFF -	Select to stop pump from operating.
MANUAL -	Pump is always on at set speed rate.
MULT/DIV -	Externally paced speed based flow meter pulses.
mA IN -	Externally paced speed based on mA input.
TIMERS -	Choose from Batch, Pulse, Recycle or 28-Day timer.
CLOCK SET -	Adjust clock settings.
PASSWORD -	Set, change, remove a password. 0000 always shown if a password is set or not.
WIFI -	Toggle Wifi ON or OFF.

Tip: To change the WiFi to On or Off, highlight WiFi and press Menu/Enter. The values will toggle with each press of Menu/Enter.

Note: The Timers menu has a selection for the auto STOP input to select if the pump stops when the input sees Open or Closed regardless of operation mode.

2.1 Off

OFF	TIMERS
MANUAL	CLOCK SET
MULT/DIV	PASSWORD
mA IN	WIFI-ON

The OFF menu is used to leave the pump forced off.

Use the Up/Down arrows (while selection choice is flashing).

Press Menu/Enter to confirm selection.

OFF	
- Push Enter -	
OFF	OFF

The run mode / status screen will change and display OFF and the pump will stop running.

Press Menu/Enter to return to the config menu.

2.2 Manual

OFF	TIMERS
MANUAL	CLOCK SET
MULT/DIV	PASSWORD
mA IN	WIFI-ON

This is where you select the MANUAL menu.

Use the Up/Down arrows (while selection choice is flashing).

Press Menu/Enter to confirm selection.

The run mode / status screen will change and display the last used manual settings. The pump will begin running.

Use the Up/Down arrow keys to raise and lower the speed. The status indicator light will turn "red" and will flash with each stroke.

Press Menu/Enter to return to the config menu.

2.5%	
5 STROKES/MIN	
MANUAL	ON

Note: The pump will stop running if the run mode / status screen is not shown.

2.3 Multiply/Divide

OFF	TIMERS
MANUAL	CLOCK SET
MULT/DIV	PASSWORD
mA IN	WIFI-ON



PULSES IN	MULTIPLY
BY	1
MAX/SPH	12000
CONFIG	EXIT/SAVE

3.0%	
6 STROKES/MIN	
PULSE	X 1

The MULT/DIV menu is used for pumps being paced by an external flowmeter. The pump can stroke multiple times per one incoming pulse or divide incoming pulses for one stroke.

Use the Up/Down arrows (while selection choice is flashing).

Press Menu/Enter to confirm selection.

This will display the MULT/DIV submenu.

Use the Up/Down arrows (while selection choice is flashing).

PULSES IN will toggle Multiply / Divide with each press of the Menu/Enter button. Use the Up/Down arrows to move to the next item.

Press Menu/Enter to select the BY value. The selection will stop flashing. Use the Up/Down Arrows to change the value from 1-1000.

Press Menu/Enter to confirm and go back up one level to allow the Up/Down arrows to select a different item. The selection indicator will begin flashing again.

Adjust the MAX/SPH value similar to BY above. Increments of 100 up to 12,000 to set maximum number of strokes per hour to limit overfeed.

Choose Exit/Save to confirm changes and return to the run mode/status screen. The status indicator light will turn "red" and will flash with each stroke. Choose Config to leave the settings unchanged and return to the config menu.

Note: The pump will stop running if the run mode / status screen is not shown.

2.4 mA In

OFF	TIMERS
MANUAL	CLOCK SET
MULT/DIV	PASSWORD
mA IN	WIFI-ON



@4mA	0%
@20mA	100%
CONFIG	EXIT/SAVE

1.0%	
2 STROKES/MIN	
mA	4.16 mA

The mA IN menu is used to control pump speed based on a 4-20mA signal.

Use the Up/Down arrows (while selection choice is flashing).

Press Menu/Enter to confirm selection.

This will display the mA submenu.

Use the Up/Down arrows (while selection choice is flashing).

Press Menu/Enter to select the @4mA value. The selection will stop flashing. Use the Up/Down Arrows to change the value from 0-100%.

Press Menu/Enter to confirm and go back up one level to allow the Up/Down arrows to select a different item. The selection indicator will begin flashing again.

Adjust the @20mA value similar to @4mA above.

Choose Exit/Save to confirm changes and return to the run mode/status screen. The status indicator light will turn "red" and will flash with each stroke. Choose Config to leave the settings unchanged and return to the config menu.

Note: The pump will stop running if the run mode / status screen is not shown.

2.5 Timers

OFF	TIMERS
MANUAL	CLOCK SET
MULT/DIV	PASSWORD
mA IN	WIFI-ON

1.0%	
Run 11:00 in 1.0gl	
WM TIMER	OFF

This menu allows the pump to be activated by one of 4 different timer types.

Use the Up/Down arrows (while selection choice is flashing).
Press Menu/Enter to confirm selection.

Timers: WM Timer, Recycle, Stop Close [Open], 28-Day, Batch. Note: Each timer has it's own submenu except Stop Close [Open].

Note: To return to the run mode / status screen, select Config in any submenu.

2.5.1 Water Meter Timer

WM TIMER	28 DAY
RECYCLE	BATCH
STOP CLOSE	
CONFIG	



RUN TIME	11:00 M:S
WM SET	ACCUM SET
CONFIG	



RUN TIME	11:00 M:S
WM SET	ACCUM SET
CONFIG	

WM UNITS	gl/Contact
WM VALUE	0001
DEBOUNCE	00 sec
	EXIT/SAVE



RUN TIME	11:00 M:S
WM SET	ACCUM SET
CONFIG	

TOTALIZER	0
RESET TOTAL	YES
RUN AFTER	0001 pl
1.0 gl	EXIT/SAVE

This timer will run the pump for a set time based on incoming water meter pulses.

Use the Up/Down arrows (while selection choice is flashing).
Press Menu/Enter to confirm selection.

Use the Up/Down arrows to select the RUN TIME minutes.

Press Menu/Enter to confirm selection. Use the Up/Down arrows to change the RUN TIME minute values from 0-59. Press Menu/Enter to confirm entry. Then, use the Up/Down arrows to go to the RUN TIME seconds. Repeat the process to update the RUN TIME seconds.

This is where you select the WM SET submenu.

Use the Up/Down arrows (while selection choice is flashing).
Press Menu/Enter to confirm selection.

Use the Up/Down arrows (while selection choice is flashing) to select the value you would like to change. Press Menu/Enter to confirm entry. Use the Up/Down arrows to change the values. Press Menu/Enter to confirm entry. Then, use the Up/Down arrows to go to the next setting. Press Menu/Enter to select the next setting. Repeat the process for editing.

Choose Exit/Save to confirm changes and return to the config menu.

This is where you select the ACCUM SET submenu.

Use the Up/Down arrows (while selection choice is flashing).

Press Menu/Enter to confirm selection. Edit with the same steps as described above in the WM SET.

Choose Exit/Save to confirm changes and return to the config menu.

2.5.2 Recycle Timer

WM TIMER	28 DAY
RECYCLE	BATCH
STOP CLOSE	
CONFIG	



ON CYCLE	00:00	M:S
OFF CYCLE	12:00	H:M
CONFIG	EXIT/SAVE	

This is where you select the RECYCLE submenu.

Use the Up/Down arrows (while selection choice is flashing).

Press Menu/Enter to confirm selection.

Use the Up/Down arrows to select the ON CYCLE minutes.

Press Menu/Enter to confirm selection. Use the Up/Down arrows to change the ON CYCLE minute values. Press Menu/Enter to confirm entry. Then, use the Up/Down arrows to go to the ON CYCLE seconds. Repeat the update process.

Press Menu/Enter to confirm selection.

Use the Up/Down arrows (while selection choice is flashing) to move to the OFF CYCLE value. Edit with the same steps as described above in ON CYCLE.

Choose Exit/Save to confirm changes and return to the config menu.

2.5.3 Stop (Auto-Stop)

WM TIMER	28 DAY
RECYCLE	BATCH
STOP CLOSE	
CONFIG	EXIT/SAVE

This is where you set the external auto-stop polarity to force the pump to stop when an external open or closed contact is seen.

Use the Up/Down arrows (while selection choice is flashing).

Press Menu/Enter to toggle CLOSE / OPEN selection.

Choose Exit/Save to confirm changes and return to the config menu.

Note: External signal cable wiring is shown on page 18.

2.5.4 28 Day Timer

WM TIMER	28 DAY
RECYCLE	BATCH
STOP CLOSE	
CONFIG	



PROGRAM 1	PROGRAM 3
PROGRAM 2	PROGRAM 4
CONFIG	EXIT /SAVE



ALL WEEKS	OFF
RUN TIME	00:00 H:M
START TIME	12:00 H:M
	EXIT/SAVE

This is where you select the 28 DAY TIMER submenu.

Use the Up/Down arrows (while selection choice is flashing).

Press Menu/Enter to confirm selection.

This is where you select the 28 DAY PROGRAM submenus.

Use the Up/Down arrows (while selection choice is flashing).

Press Menu/Enter to confirm selection.

Use the Up/Down arrows to select the ALL WEEKS values.

Press Menu/Enter to confirm selection. Use the Up/Down arrows to change the ALL WEEKS values. Press Menu/Enter to confirm entry. Then, use the Up/Down arrows to go to the RUN TIME hour. Repeat the process to update the RUN TIME minutes and START TIME hour and minutes.

Choose Exit/Save to confirm changes and return to the config menu.

2.5.5 Batch Timer

WM TIMER	28 DAY
RECYCLE	BATCH
STOP CLOSE	
CONFIG	



	RUN BATCH
RUN TIME	00:00 H:M
CONFIG	EXIT/SAVE

This is where you select and set the BATCH submenu.

Use the Up/Down arrows (while selection choice is flashing).

Press Menu/Enter to confirm selection.

Use the Up/Down arrows to select the RUN TIME hour.

Press Menu/Enter to confirm selection. Use the Up/Down arrows to change the RUN TIME hour values. Press Menu/Enter to confirm entry. Then, use the Up/Down arrows to go to the RUN TIME minutes. Repeat the update process.

Press Menu/Enter to confirm selection.

Choose Exit/Save to confirm changes and return to the config menu.

Note: Choose RUN BATCH to immediately jump to the run mode / status screen and begin the countdown process.

2.6 Clock Set

OFF	TIMERS
MANUAL	CLOCK SET
MULT/DIV	PASSWORD
mA IN	WIFI-ON



TIME	15:49 H:M
DAY	TUESDAY
WEEK	3
15:54:43 TUESDAY	W=3 EXIT/SAVE

This is where you select the CLOCK SET menu.

Use the Up/Down arrows (while selection choice is flashing).

Press Menu/Enter to confirm selection.

Note: The pump time must be re-adjusted if this menu is selected.

This will display the CLOCK SET submenu.

Use the Up/Down arrows (while selection choice is flashing).

Press Menu/Enter to select the TIME hour value. The selection will stop flashing. Use the Up/Down Arrows to change the value from 0-23.

Press Menu/Enter to confirm and go back up one level to allow the Up/Down arrows to select a different item. The selection indicator will begin flashing again.

Adjust the TIME minutes value similar to TIME hour above.

Increments of 00 up to 59.

Adjust the DAY and WEEK values similar to TIME above.

Choose Exit/Save to confirm changes and return to the config menu.

2.7 Password

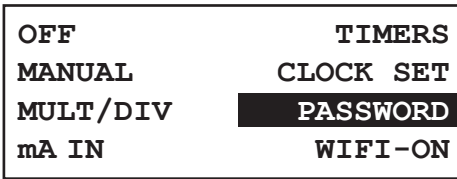

This is where you select the PASSWORD menu.

Use the Up/Down arrows (while selection choice is flashing).

Press Menu/Enter to confirm selection.

This will display the PASSWORD screen.

Use the Up/Down arrows (while selection choice is flashing) to change the value from 0-9. Press Menu/Enter to confirm entry. Then, use the Up/Down arrows to go to the next number. Press Menu/Enter to select the next number. Repeat the process for editing all 4 numbers.

Choose Exit/Save to confirm changes and return to the config menu.

Note: The password will become active approximately 2 minutes after key press inactivity. If a pump has a password it will be required to make changes via the WiFi connection. A setting of 0000 will disable the password protection.

2.8 WiFi

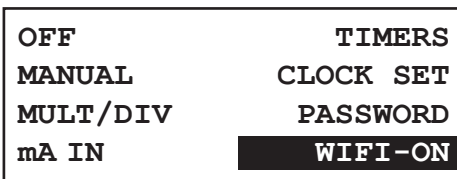

This is where you select the WIFI menu.

Use the Up/Down arrows (while selection choice is flashing).

Press Menu/Enter to toggle between WIFI-ON and WIFI-OFF.

Note: The Wifi portion of the pump is an Access Point only. You will typically need to be within 300 feet line of site to connect to the pump. To interface and configure pump, download the Air Advantage app from the Google Play store or Apple app store. You may also manually connect to the pump through a browser without the AirAdvantage app.

The pump's Wifi SSID and Pass will also be required. They are located on the label on the top of the pump.



Air Advantage

Access WebAdvantage, System Builder, product manuals, and other water treatment tools all from one place. Available for free on the Apple app store and Google Play store.



AirAdvantage App WiFi Connection

Step 1:

Open the AirAdvantage app.

Press the "Linx" button.

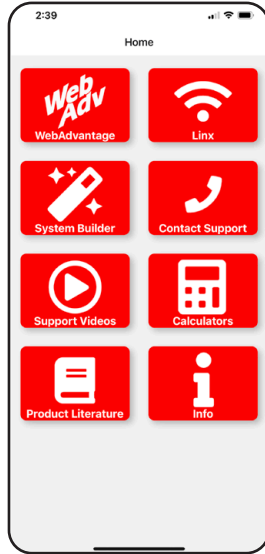

Step 2:

Press "Add Device" or the "+" button.

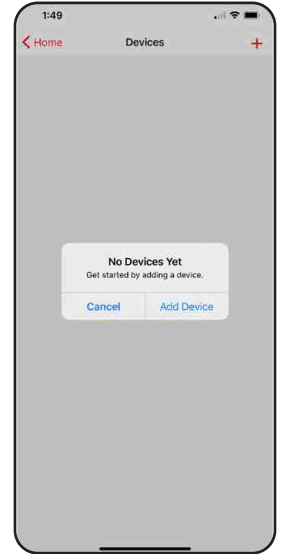

Step 3:

Enter a custom Name.

Enter the pump's Wifi SSID.

Press the "Submit" button.



Step 4:

The pump will be added to the list.

Press the pump name or right arrow to continue.

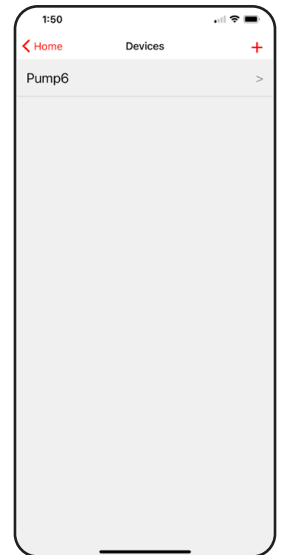

Step 5:

Press the "Connect" button.

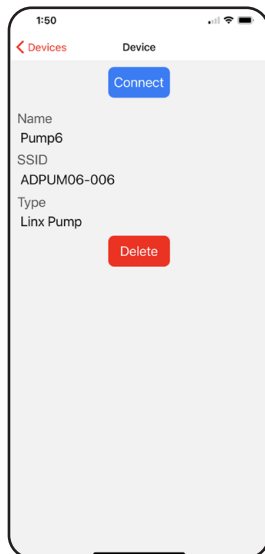

Step 6:

Press "Join" to continue.



Step 7:

Connected successfully.

Press "OK" to continue.

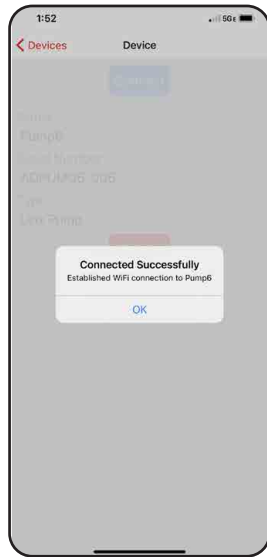

Step 8:

Pump run screen.

Press the "Configure" button to continue.

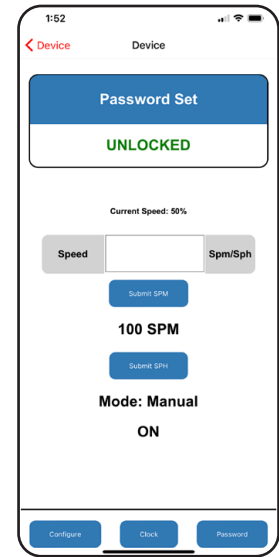

Step 9:

Configure screen.

Press a button to make changes as previously described in this manual.

If a password has been entered it will be required to make changes to settings.

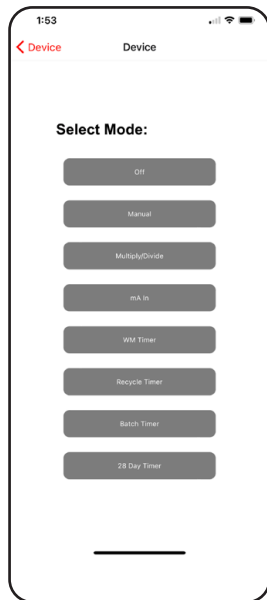

Browser Manual WiFi Connection

Step 1:

Open Wifi connections on your device.

Press the connection listed as the pump's Wifi SSID.



Step 2:

Enter the password.

Note: This is located on the pump's Wifi SSID label on top of the pump.

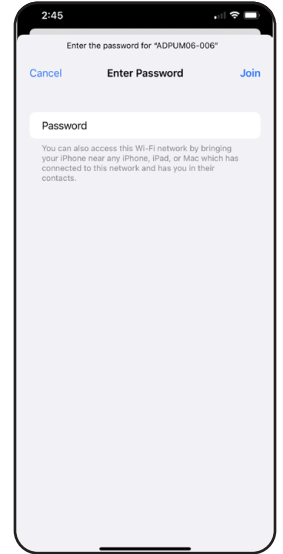

Step 3:

After connection is made, click on the "information" icon.

Record the router IP address.

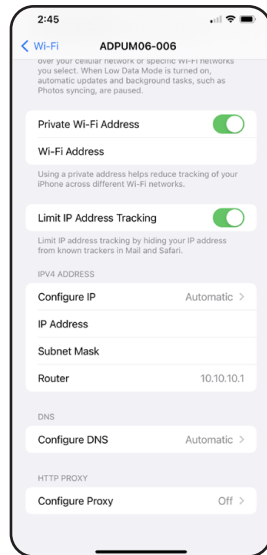

Step 4:

Enter the router IP address as the website URL and press enter/return/go.

Note: The wifi connection will disconnect if the browser is closed.

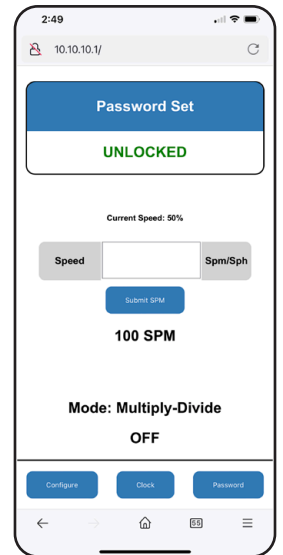

External Signal Cable Wiring

MLCABLE-7P7-9

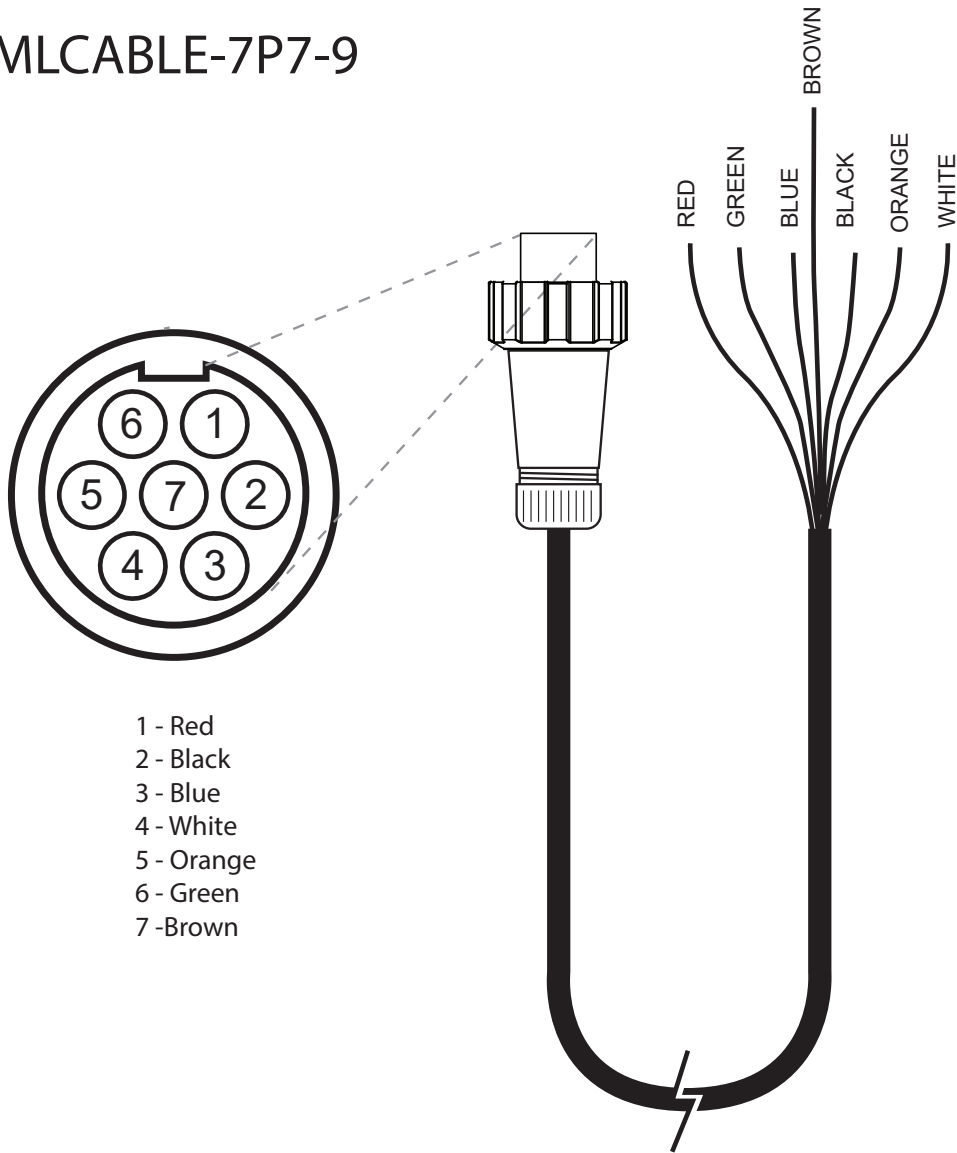

- 1 - Red
- 2 - Black
- 3 - Blue
- 4 - White
- 5 - Orange
- 6 - Green
- 7 - Brown

MicroLinx Pump Connections

- 1 - Red = Auto stop
- 2 - Black = Auto stop / common
- 3 - Blue = Pulse in / common
- 4 - White = +4-20mA input
- 5 - Orange = Pulse in
- 6 - Green = 4-20mA / common
- 7 - Brown = +5 VDC *

* Only on pumps with Control option P

Input Specifications

Auto stop and Pulse In - From open collector/open drain output or dry contact. Input has 499 Ω pullup to 5 VDC through an optical isolator.

mA input - The externally supplied loop current must not exceed 25 mA using a typical loop power of 12-24 VDC.

PVDF Liquid End Diagram

Item	Description
1	Complete Head Kit*
2	Injection Valve
3	Foot Valve
4	Suction Valve
5	Discharge Valve
6	Priming Valve Assembly
6a	Degassing Valve Assembly
7	Pump Head
8	Priming Tube Assembly
9	Priming Tubing
10	Head Bolts
11	Diaphragm
12	Support Ring
13	Shaft Seal
14	Discharge Tubing
15	Suction Tubing
16	Weight

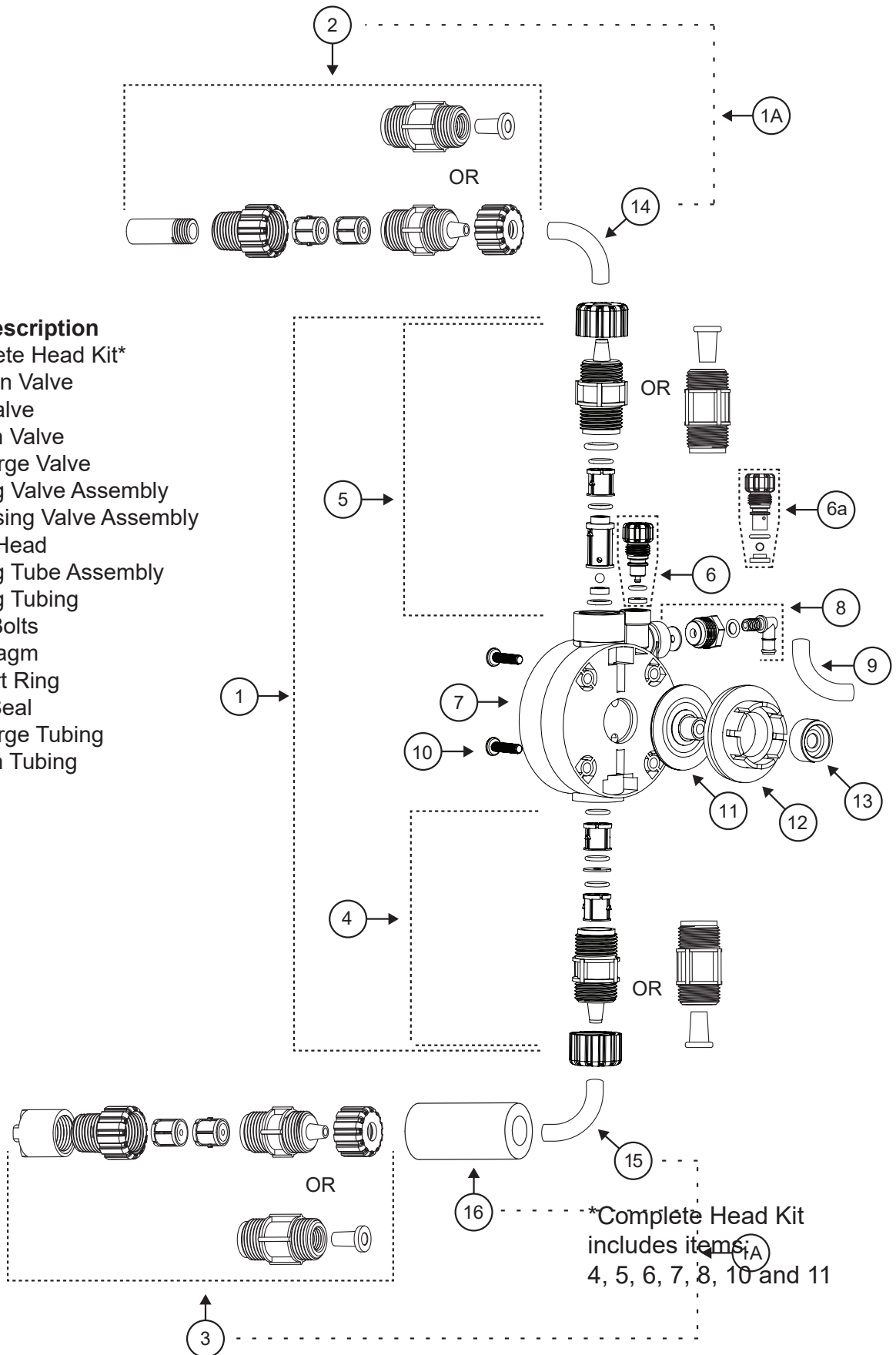

Replacement Parts

Getting the right materials of construction for your spare parts is easy. Using positions 6-9 of the pump model number, example: L30X1-**KFCV**. Find the assembly needed and add the codes of your pump's liquid end after the standard prefix part number for the assembly.

NOTES:

- Complete head assemblies use positions 2 and 3 of the pump model number plus 6-9 to identify the correct part number. Example L**30**X1-**KFCV** uses a CHL-30-KFCV.
- Stainless steel heads liquid end is always SFSP and the head kit is CHL-___ - SFSP.
- Stainless steel heads suction and discharge valve part # is **R00325**.

Part Assemblies

Item	Description	Part Number
1.....	Complete Head Assembly.....	CHL- ___ - ___

Body	Seat	Ball	Connection	
D — PVDF/Degas	V — Viton	C — Ceramic	1 — 3/8" tube	R — 1/4" FNPT
K — PVDF	F — Teflon	S — Stainless	2 — 1/4" tube	U — 3/8" tube
S — Stainless Steel	H — Hypalon		P — 1/4" MNPT*	V — 3/8" tube

*SS head only.

All PVDF Assemblies		
2.....	Injection Valve Assembly	INJ-L- K ___
	3-Function Injection Valve	3FV- K ___
3.....	Foot Valve Assembly	FTV-L- K ___
4.....	Suction Valve Assembly	SUC-L- K ___
5.....	Discharge Valve Assembly	DIS-L- K ___
6.....	Priming Valve Assembly.....	PRI-L- K F ___
6a.....	Degas Valve Assembly.....	DGS-L- K V ___
8.....	Priming Tube Assembly.....	PRT-L- K ___

Seat	Ball	Connection
V — Viton	C — Ceramic	1 — for all 3/8" tubing
F — Teflon		2 — for all 1/4" tubing
H — Hypalon		R — for 1/4" FNPT

Single Parts

9.....	Priming Tubing	R00255
14.....	Discharge Tubing 3/8" PE	R00122
	Discharge Tubing 1/4" PE	R00267
15.....	Suction Tubing 3/8" Clear	R00255
	Suction Tubing 3/8" PE	R00122
	Suction Tubing 1/4" PE	R00097
16.....	Tubing Weight	R00139

Maintenance

The Advantage pump is designed for long service life with minimum maintenance. If for any reason, maintenance is necessary or desirable, the pump is easily maintained.

Before any maintenance or service is performed, observe the following precautions:

1. Disconnect the pump from power source.
2. Drain chemical from discharge tubing.
3. Disconnect discharge tubing from pump.
4. If the pump is used in a flooded suction application, remove foot valve from solution container.
5. Observe relevant safety protocols when handling parts which have been in contact with hazardous chemicals.

Diaphragm Replacement

1. Remove fluid end cover by lightly prying it loose from the fluid end.
2. Remove the four screws attaching the fluid end to pump body.
3. Remove the fluid end from the pump body.
4. Unscrew the diaphragm from the pump shaft in a counter-clockwise direction. Be careful that diaphragm support ring does not fall out.
5. Do not allow sharp or abrasive objects to come in contact with pump parts.
6. Inspect end of shaft to assure that threads are in good condition. Replace shaft bellows if necessary. No further disassembly is recommended.
7. Screw new diaphragm onto pump shaft until it bottoms out on shoulder of shaft. It is not necessary to tighten further.
8. Replace fluid end. Make sure that screws are evenly tightened.
9. Reconnect plumbing and power. Prime the pump.

Suction and Discharge Check Valve Replacement

1. Disconnect suction tubing from pump.
2. Unscrew fitting from pump head.
3. Remove check valve from suction fitting and replace.
4. Remove O-ring from cavity in fluid end.
5. Remove check valve from suction side pump and replace.
6. Install new O-ring in cavity of fluid end.
7. Replace valve fitting with check valve in fluid end.
8. Replace fluid end. Make sure that screws are evenly tightened.
9. Reconnect plumbing and power. Prime the pump.

- NOTES:**
1. Tighten pump head screws after pump's initial week of operation.
 2. When installing check valves, remember that the seats are always installed at the bottom.

Trouble Shooting

PROBLEM	CAUSE	REMEDY
Pump does not achieve or maintain prime	Air trapped in suction line	Straighten suction line so as to eliminate high spots.
	Foot valve contaminated or improperly installed	Inspect foot valve screen and assure that foot valve is in a vertical position below fluid level.
	Excessive lift	Maximum suction lift is 5 feet with water or fluids of similar specific gravity; less with heavier liquids such as acids. Mount pump in a lower position relative to the solution container.
	Suction fittings not properly tightened	Check fittings. Overtightening may cause restriction. Conversely, if any leakage occurs, pump will suck air and fail to prime.
	Worn or contaminated check valves	Inspect check valves in fluid end for cleanliness. Clean or replace as necessary.
	Split or pinch in suction tube	Inspect suction tube through its full length to assure that there are no splits at the connections or other restrictions. Move any objects or equipment which impinges upon suction tube or reroute as required to assure a smooth transition from foot valve to pump.
	Low chemical level	Check fluid level in chemical supply tank.
Excessive fluid	Failure or lack of antisiphon valve	Inspect or add anti-siphon valve. This is caused when system is in a vacuum condition or valve in delivery applications with flooded suction which feeds systems at very low pressures.
	Excessive stroke rate	Lower the stroke rate if adjustable on your pump.
Pump will not pump	System pressure too high	Check system pressure to assure that it is within system rated parameters of the pressure.
	Diaphragm improperly installed	Make sure that diaphragm is screwed fully unto shaft.
	Check valves worn or clogged	Clean or replace as required.

Output Curves

MicroLinx outputs are rated based on pumping against the maximum PSI for the particular model.

If it is not pumping against the maximum pressure it is rated for it will be able to pump at greater volumes.

The output curves provide an estimated output of each model when pumping at lower pressures.

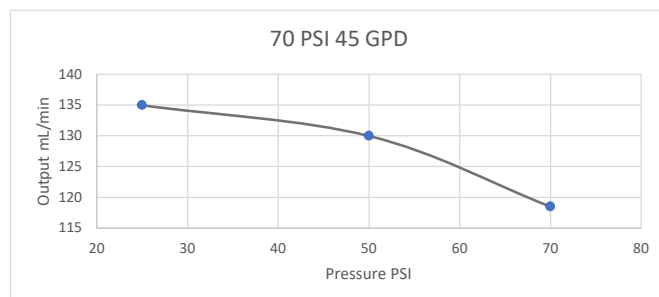
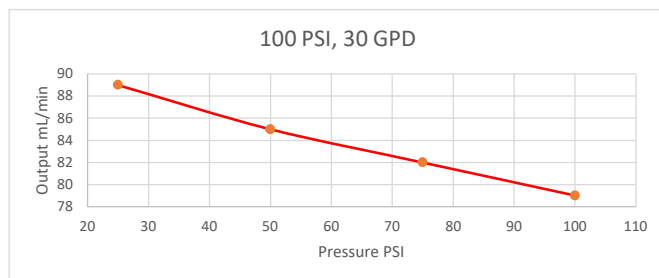
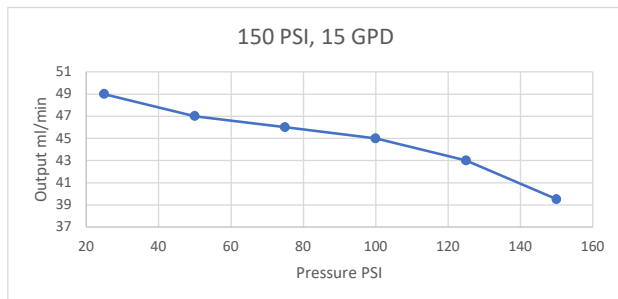
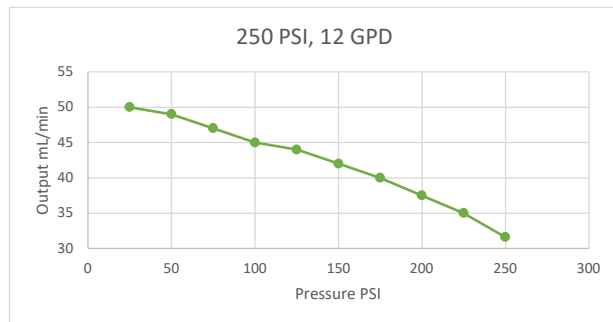
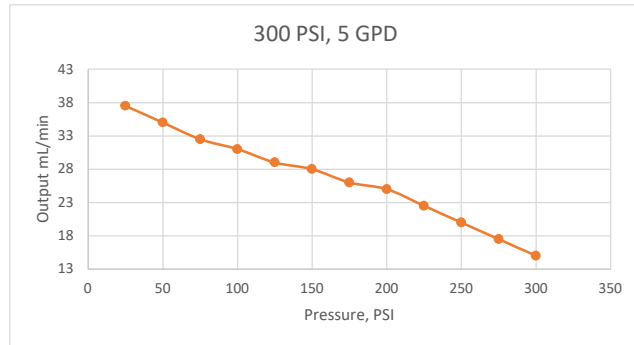

Get the Advantage in Water Treatment Equipment

Advantage Controls can give you the *Advantage* in products, knowledge and support on all of your water treatment equipment needs.

- Cooling Tower Controllers
- Boiler Blow Down Controllers
- Blow Down Valve Packages
- Bleed Valves
- Water Meters
- Metering Pumps
- Corrosion Coupon Racks
- Solution Tanks
- Solid Feed Systems
- Bypass Feeders
- Filter Equipment
- Glycol Feed Systems
- Pre-Fabricated Systems

